



Latest update of this document, June 20, 2007

The Dokeos 1.8.2 Installation Manual

Dokeos 1.8.2 LMS

Oogie Rapid Authoring
Dokeos Live Conferencing





Introduction

The goal of this guide is to help you install Dokeos 1.8.x from A to Z, i.e. from buying or renting the server up to running the application.

Dokeos 1.8.x is a major release. It offers much more than its previous 1.6 release. Where it provided a Learning Management System only, this new version also provides Rapid Authoring, Videoconferencing and SCORM reporting.

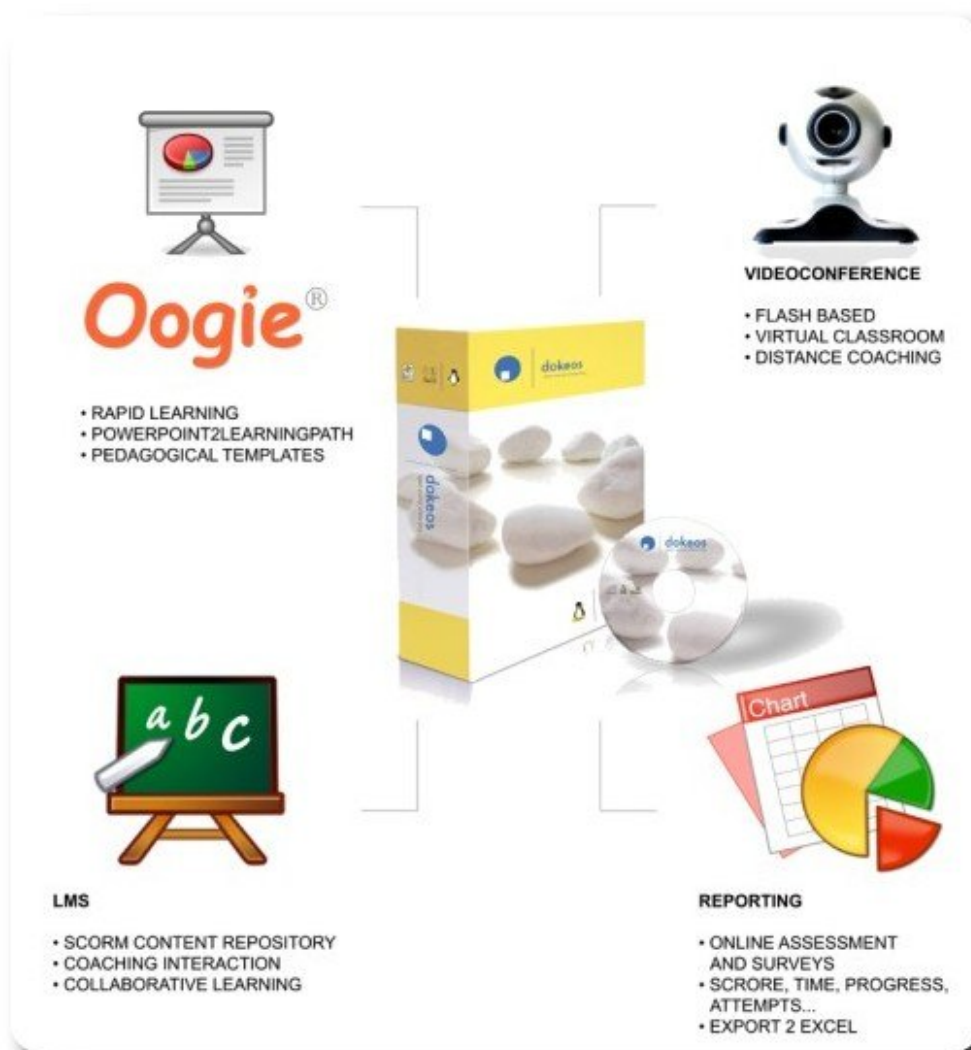

From a technical perspective, this set of features is provided by a sophisticated server environment. The purpose of this manual is to help install and configure this server.

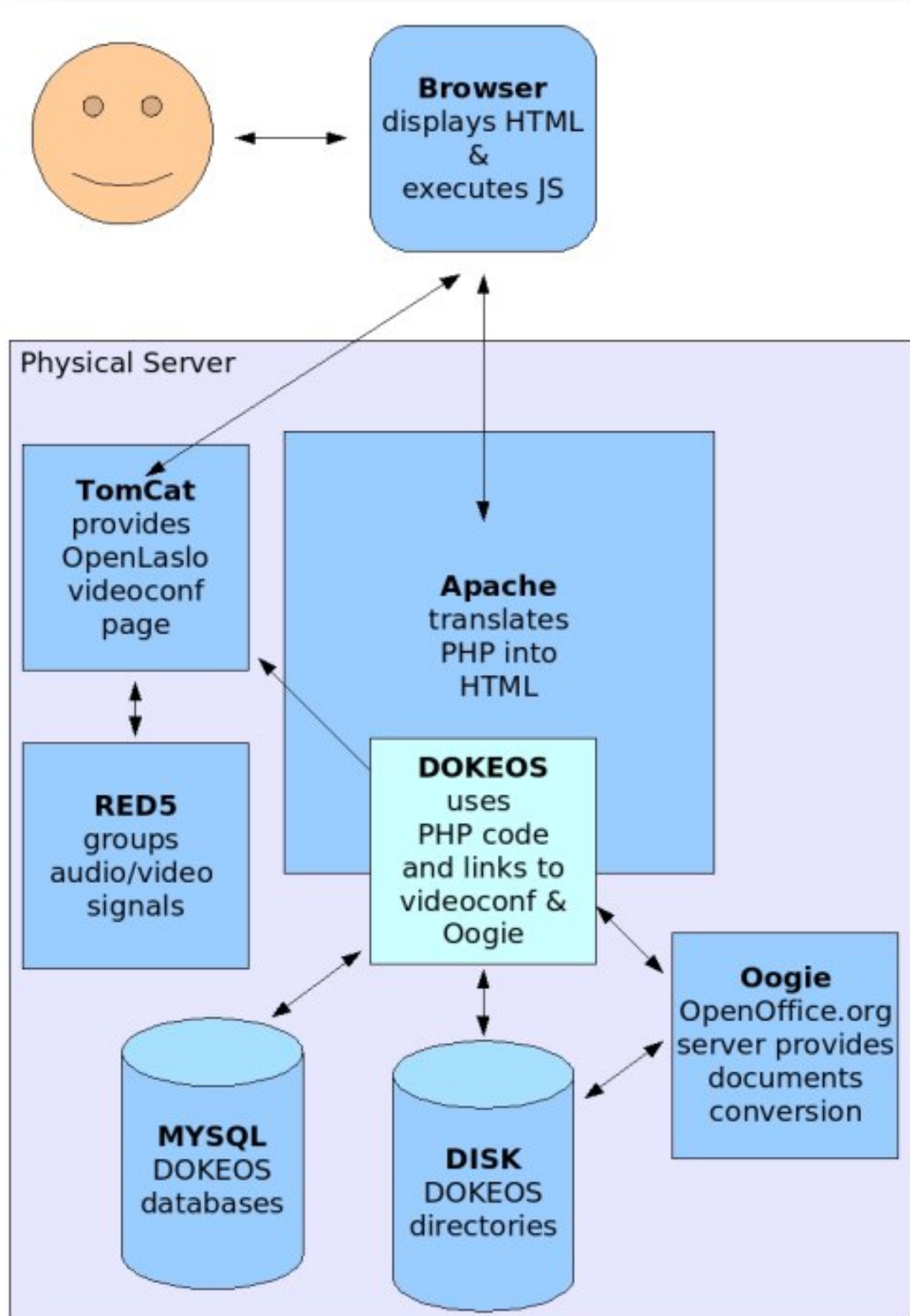



This is made possible thanks to the most recent developments of the Open Source community. The strength and flexibility of the Dokeos 1.8 solution is that it runs on almost any computer and almost any browser thanks to the fact that Dokeos is a web-based application.

However, the evolution of Dokeos implies more complexity server-side. While Dokeos 1.6 relied on basic L.A.M.P. technology (Linux Apache, MySQL, PHP), the full version of Dokeos 1.8 relies on various Open Source and freely available server technologies :

GNU/Linux (we support Debian-based distributions such as Ubuntu for the flexibility of their « apt-get » remote install protocol)

Dokeos should run on Microsoft Windows however this is not really tested at the present time.

- Apache 2.x
- MySQL 4+
- PHP 5 (version 5.2 is recommended for dynamic upload progress bar capability)
- OpenOffice.org 2.x server-side to convert PowerPoint and Impress presentations online into PNG images for Videoconference presentations and SCORM-compliant Learning paths



- Red5 server : Java-based Open Source server for duplex Flash-based audio/video live conferencing and audio recording in Oogie Rapid Authoring technology
- OpenLaszlo : Videoconferencing whiteboard technology
- Apache Tomcat server to deliver OpenLaszlo technology to the web

Nevertheless, Dokeos 1.8.x LMS will still run on a basic L.A.M.P. server provided you do not activate **Live Conferencing** and **Oogie Rapid Authoring** through the web-based Dokeos administration interface.

Buying or renting a server machine

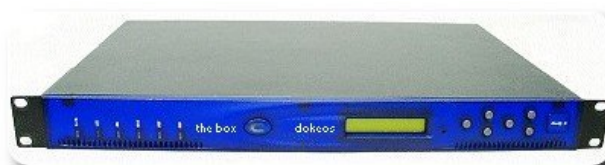



Dokeos is a web-based technology. This means you need a server. Here are some good practice recommendations.

As bandwidth and 24/7 availability are usually critical for a server, we recommend the use of a professionally-maintained one. Raw hosting is cheap nowadays and you can find a hosting company close to your place.

Prefer companies which allow shell (SSH) access on the server instead of only web-based admin like Plesk or cPanel. This will give you more control to install and maintain the list of Dokeos critical applications.

The characteristics of your server might look like this today :

1Gb RAM minimum

80 Gb Hard Disk

10 Mb/s minimum bandwidth

To improve performance, consider more RAM and more bandwidth. Two CPU is also an option.

The Dokeos company provides a wide range of technical services to help you in the whole process : from 20-hours installation support pack to turnkey hosting + support + maintenance 12-months contracts. See <http://www.dokeos.com> for more details.

Operating System installation

If the server machine is not provided with the OS pre-installed you will have to install it. The Dokeos company, along with the community, already tested Dokeos 1.8 on the following OS for servers : Ubuntu 6.06, 6.10, 7.04 and Debian Etch (or even Sarge, with some backports).

In theory, any GNU/Linux distribution would do. As for Windows servers, all the packages required are available but the process has not been fully-tested so far. However, as we cannot detail every option and because it is a good option both for the laptop and the server, this manual focuses on Ubuntu Linux as both an example installation and the most comfortable one.

A simple way to get Ubuntu is to buy, download an ISO or get a free copy of Ubuntu (7.04 Feisty Fawn at the time of this manual) from <http://www.ubuntu.com>. Any further release of Ubuntu should do as well. Note that newest releases would ease your installation of Dokeos.





Check in the machine Setup (usually F2 when starting the machine) that it can boot on CD-Rom, insert your Ubuntu in the CD-Rom player and start the server. It will first startup a Live Ubuntu distribution and then offer to install it on the Hard Disk. Follow the instructions, there is not so much choice there, so the risk of making mistakes is limited. Do not try to install the exact set of software you would want immediately, you will have plenty of time to do this later on.



If you first want to learn more about Ubuntu, check : <http://www.ubuntu.com/ubuntu>

Once installation is over and especially if your CD is old, you might want to upgrade to a newer release or at least upgrade the packages that have evolved since the CD was burnt. Go to <http://www.ubuntu.com> to check for the automatic version upgrade and packages upgrade.

You may also want to have a look at <http://ubuntuguide.org> that provides plenty of useful and simple tips and tricks on how to improve your Ubuntu distribution, install proprietary software that are not included on the CD like Flash Player.



Now open a Shell



and do a :

```
sudo apt-get update  
sudo apt-get upgrade
```

This will download and install automatically a long series of upgrades.

Time for a coffee.



After this, you may have to restart your computer. Maybe more than once as it might ask for additional upgrades to fit the already installed ones (this belongs to a process called *dependencies* management: one layer of software requires another that requires another, etc.)

For more details on installing and configuring Ubuntu, we invite you to check for Ubuntu documentation: <https://help.ubuntu.com/>

If you have physical access to the server (probably not the case if you rent a server at a hosting company), check that the following components are up and running :

- Network (you should know the IP address and, if applicable, the domain name of your server)
- OpenOffice.org 2.x
- Firefox
- Java RunTime Environment 1.5 and Java Development Kit (use the Sun ones preferably, they currently offer better performance)
- Microsoft fonts will improve rapid authoring results as you will convert PowerPoint presentations that use Microsoft fonts. The *msttcorefonts* package should be installed. You can check this in the fonts scroll menu of OpenOffice.org.
- Exim, Sendmail or Postfix mail server



- A backup or crash recovery system. We recommend at least FTP or Rsync. These allow you to copy your critical data onto a second server machine. More sophisticated systems like RAID and load-balancing are also an option when uptime is critical.

The server should be accessed by a unique name, independently of the location from which you may access it. If you use the server via different IP addresses, you will run into problems. The unique name used to access this server is stored into the Dokeos configuration file. If you ever change this name, you need to modify the configuration file of your Dokeos installation. Some image links may also have to be updated manually.

Adding software to default Ubuntu from UbuntuGuide.org



You are now ready to add software from repositories following UbuntuGuide. Search for the install procedure of these software in UbuntuGuide (the process is described there and you can use the Firefox default search feature : Edit > Find on this page) : <http://ubuntuguide.org/>

- SUN Java 1.5 JDK

```
sudo apt-get install sun-java5-jdk
```

To ensure your default Java version is 1.5, type `java -version`. If you have several installed and want to change the default version, use `sudo update-alternatives --config java`.

Note that running Dokeos' Java parts with Java 6 (also called Java 1.6) is not supported so far. Please install Java JRE 5 and JDK 5.

- Extra fonts. Important for the Oogie conversion tool that will be able to convert Microsoft fonts like Verdana and Comic Sans Ms or Arabic fonts only if these fonts are installed on the server, especially in package `msttcorefonts` (for Microsoft Core Fonts)

Note that if you are behind a proxy you can use the following command (prefixed with the usual `sudo`)

```
update-ms-fonts -proxy.company.com:3128 -uhttp://ovh.dl.sourceforge.net/sourceforge/corefonts/
```

The L.A.M.P. architecture

The core of Dokeos 1.8 is a web-based Learning Management System relying on

- **Apache2;**
- **MySQL-5.0;**
- **PHP5;**



- **(PhpMyAdmin;)**
- and various **PHP modules**

This package list will evolve. This is the picture as of today.

Apache 2.0



In Ubuntu Linux, software installation mainly consists in typing « `sudo apt-get install softwarepackagename` ». This will download the package and install it immediately. This supposes you get a rather fast access to the Internet. Otherwise you will have to find the packages on a CD or any other support and use « `dpkg -i` ».

To install Apache2, you just have to type :

```
sudo apt-get install apache2-mpm-prefork
```

MySQL 5.0



To install MySQL 5.0 just type :

```
sudo apt-get install mysql-server-5.0
```

PHP 5 (and matching Apache and MySQL modules)



Type:

```
sudo apt-get install libapache2-mod-php5 php5-mysql
```

During the install, you may see warnings like:



```
apache2: Could not determine the server's fully qualified domain name.
```

You may safely ignore them. You just have to add the `ServerName` value in
« `/etc/apache2/apache2.conf` »

```
ServerName www.mysite.com
```

Pre-tests

Now you should check if you can run your web server properly

- Apache
- PHP

Reload the Apache configuration to see if it takes all your changes into account:

```
sudo /etc/init.d/apache2 reload
```

And with Firefox, type the following URL :

```
http://localhost/
```

Note If you use a proxy you should add `localhost` in the addresses available without proxy in your browser preferences.

If all goes well you should see a default page for the Apache Server.

Name	Last modified	Size	Description
 apache2-default/	26. Jul. -2006 23:53	-	

Apache/2.0.55 (Ubuntu) PHP/5.1.2 Server at localhost Port 80

Check now if PHP5 works fine:

Open Gedit with « `sudo gedit` » and create a file called `phpinfo.php` in `/var/www` where you type :



```
<?php phpinfo (); ?>
```

Now enter your browser and type:

```
http://localhost/phpinfo.php
```

You should see something like:

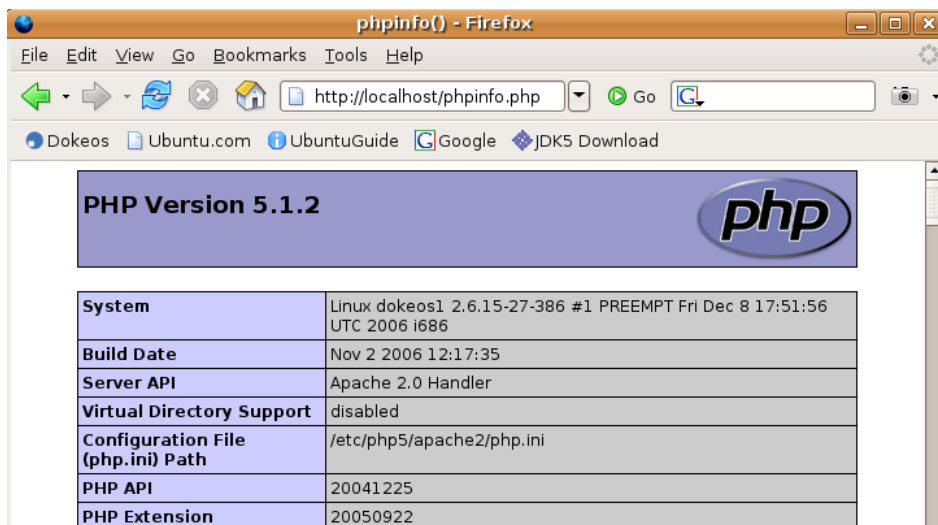

If you see :

```
Warning: Unknown: Failed opening '/var/www/phpinfo.php' for inclusion  
(include_path='.:usr/share/php:/usr/share/pear') in Unknown on line 0
```

Then you have a permission problem on the file. Type :

```
sudo chmod 755 /var/www/phpinfo.php
```

PHP is the core of your Dokeos installation. You will need to install a few complementary modules so that PHP accepts all the requests you will make, like zipping a file, crypting a password, resizing an image, etc. Type :

```
sudo apt-get install php-pear php5-gd php5-xsl php5-mcrypt
```

Once PHP is installed, edit /etc/php5/apache2/php.ini and search on the words « max » and « memory ».

You may want to change the following variables to these values :



```
max_execution_time = 300 ; Maximum execution time of each  
script, in seconds
```

`max_input_time = 600 ; Maximum amount of time each script may spend
parsing request data`

`memory_limit = 32M ; Maximum amount of memory a script may
consume (8MB)`

`post_max_size = 16M ; Maximum size of a POST request`

`upload_max_filesize = 100M ; Maximum upload file size`

Enhance MySQL security

So far, your MySQL installation is not protected. It runs under username « root » with empty password. Type the following command and follow the steps:

```
sudo mysql_secure_installation
```

Install PhpMyAdmin

While optional for Dokeos, PhpMyAdmin will allow you to manage your MySQL databases through the web. It is not necessary but can really make things easier.

Type :

```
sudo apt-get install phpmyadmin
```

Check that PhpMyAdmin works fine, typing the following URL in your browser:

```
http://localhost/phpmyadmin/
```

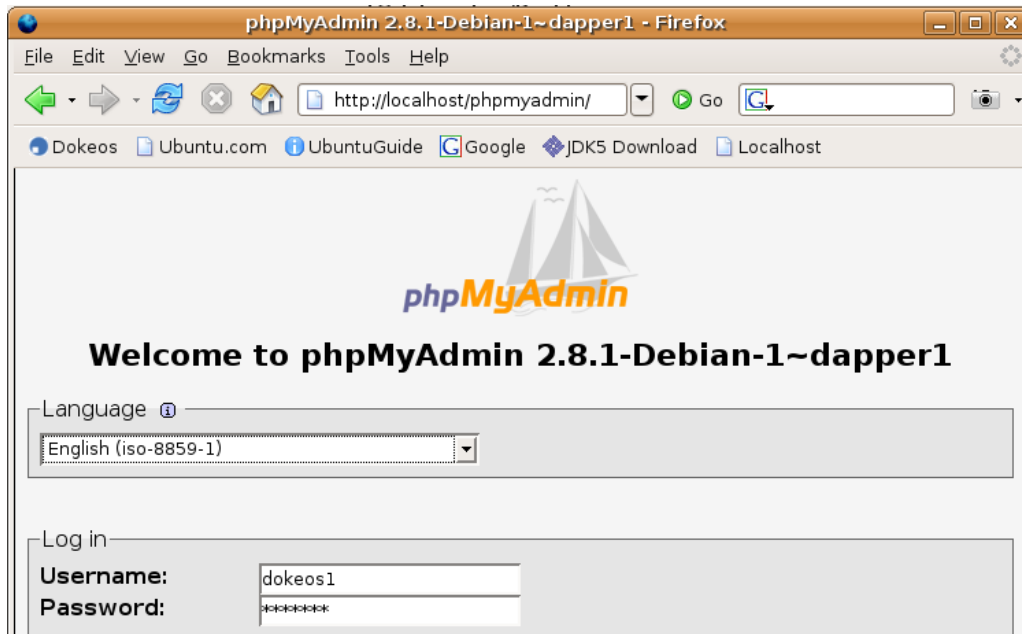

Install Dokeos 1.8.2

REM : to **upgrade** from Dokeos 1.6.5 or Dokeos 1.8.0, go to pages 15-16.

Download Dokeos 1.8.2 from <http://www.dokeos.com/download.php> and unzip or untar it inside /var/www/

A simple way to do this is to type:

```
sudo nautilus
```

and use this file manager to move the ZIP file to /var/www and right-click on it to unzip it.





Go into `/var/www` and type « `chmod 0777 -R dokeos-1.8` » to allow write permissions on all the files of the Dokeos installation. You will close this later on (using `chmod 755` and for config files `644`) to avoid security problems.

Alternatively, you can do this from your terminal by typing the following commands in turn :

```
cd /var/www  
  
sudo wget http://www.dokeos.com/download/dokeos-1.8.2.zip  
  
sudo unzip dokeos-1.8.2.zip  
  
sudo chmod -R 0777 dokeos/
```

Next, open Firefox and type <http://localhost/dokeos/> and click on Install.

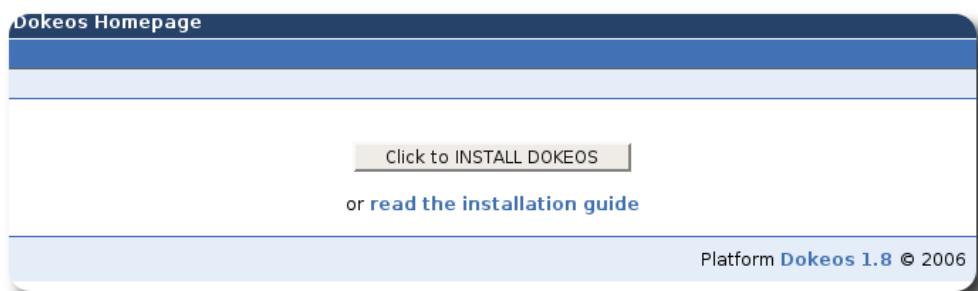

Then follow the instructions.

Congratulations ! You have installed the core of Dokeos 1.8.2. Don't forget to restrain the permissions on `dokeos/main/inc/conf` and other folders as required. Read the documentation carefully and get advice from a system administrator for the right way to do that.



Authoring

- Course Description
- Learning Path
- Tests
- Documents
- link
- Live conferencing (classroom)

Interaction

- Agenda
- Forums
- Users
- Chat
- Live conferencing
- Announcements
- Dropbox
- Groups
- Student Publications

Administration

- Blogs management
- Course settings
- Course Maintenance
- Tracking
- Surveys

Upgrading from Dokeos 1.6.5 or Dokeos 1.8.0

Upgrade from Dokeos 1.8.0 to Dokeos 1.8.2

Same as Dokeos 1.8.0 installation process for package download and unzip. Then overwrite the Dokeos 1.8.0 files on the server. This means using the directory created when unzipping, for instance « dokeos » and copying the Dokeos 1.8.2 folder over the Dokeos 1.8.0 folder. For example:
`cp -r dokeos-1.8.2/* my_install/` (you will need « write » user rights on the files to proceed, might need a `CHMOD 755 -R *`).

Open your browser and go to the Dokeos installation directory, for instance <http://localhost/dokeos/main/install/>

Then follow the assistant and select at step 2 : « Upgrade from Dokeos 1.8.0 ».

Oogie installation and **Videoconferencing** installation are identical in Dokeos 1.8.0 and Dokeos 1.8.2 and you should see no changes in this.

Upgrade from Dokeos 1.6.5 to Dokeos 1.8.2

You will have to upgrade from Dokeos 1.6.5 to Dokeos 1.8.0 first. This means downloading Dokeos 1.8.0 from <http://www.dokeos.com/download.php>, then copy it onto the web server besides the Dokeos 1.6.5 install, open the browser and go to your Dokeos 1.8.0 install home, for instance <http://localhost/dokeos180/>, then follow the assistant and select « Upgrade from Dokeos 1.6.5 ».

After this, upgrade from Dokeos 1.8.0 to Dokeos 1.8.2 (see above).

Pre-requisites for Dokeos Oogie Rapid Authoring PowerPoint conversion

We will now install the Oogie PowerPoint2LearningPath. This, together with the Live Conferencing plugin, is probably the trickiest part.

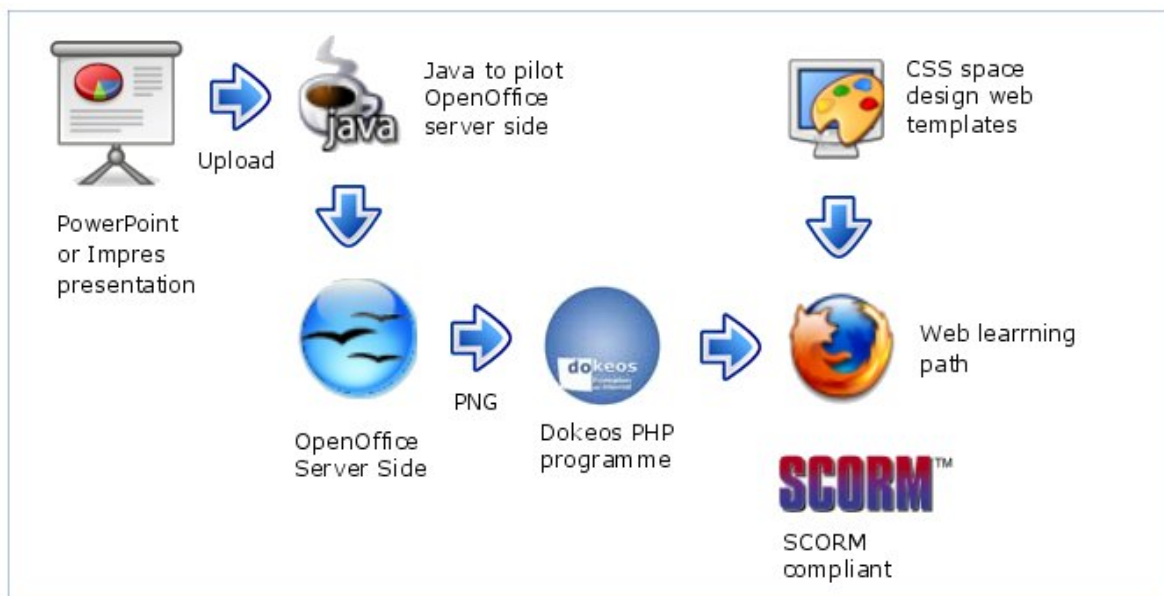

Let's start with the pre-requisites for Oogie (PowerPoint/Impress conversion).

You will need



- a recent Java SDK (Software Development Kit) to pilot OpenOffice.org. If you didn't install it as a package already, get Java SDK on <http://www.java.com/getjava> (note that today's Dokeos does not work with JDK 6, use JDK 5 instead).
- OpenOffice.org 2.x to do the conversion of slideshows into PNG images. This might already be installed on your computer.

Once OpenOffice.org is there, install Microsoft fonts to allow elegant conversion of PowerPoint/Impress presentations that may include fonts like Verdana, Comic Sans Ms, etc.

```
sudo apt-get install msttcorefonts
```

Once the latest version of OpenOffice.org is installed, edit the configuration file (setup.xcu) and add the following property :

```
<prop oor:name="ooSetupConnectionURL">  
<value>  
socket,host=localhost,port=2002;urp;StarOffice.ServiceManag  
er  
</value>  
</prop>
```

NOTE : you should put it next to :

```
<prop oor:name="ooSetupInstCompleted">  
<value>>false</value>  
</prop>
```

(eg.: /usr/lib/openoffice/share/registry/data/org/openoffice/Setup.xcu on Debian or Ubuntu)

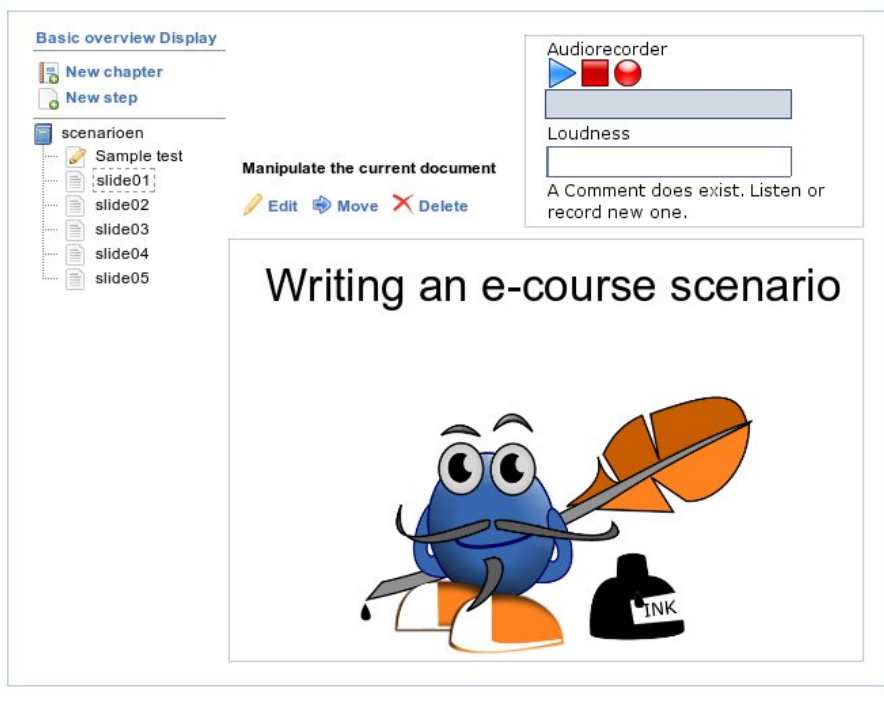

For the basic conversion of a presentation to Dokeos, you need to run the OpenOffice.org server in headless mode. On GNU/Linux systems this is done via the X virtual framebuffer (xvfb package). If your server does not already feature the X Window System, additional fonts and basic X libraries will have to be installed.

To install xvfb, type the following command on an Ubuntu/Debian system:

```
sudo apt-get install xvfb
```

It is recommended to create a new system user dedicated to running the OpenOffice.org server as well as OpenLaszlo and Red5. You will need to start OpenOffice.org with this user once so that the basic configuration files get created.

If during the conversion process you need sound recording, then the installation of the OpenLaszlo and Tomcat modules are needed (see below).

The automatic startup of this service at boot can be done using the proposed initscript ooserver.init available from the Dokeos wiki at <http://www.dokeos.com/wiki/index.php/MakeOOOListening>

This page also explains how to start the OpenOffice.org server in listening mode (even without modifying the setup.xcu file).



Configure the call to OpenOffice.org in Dokeos Admin

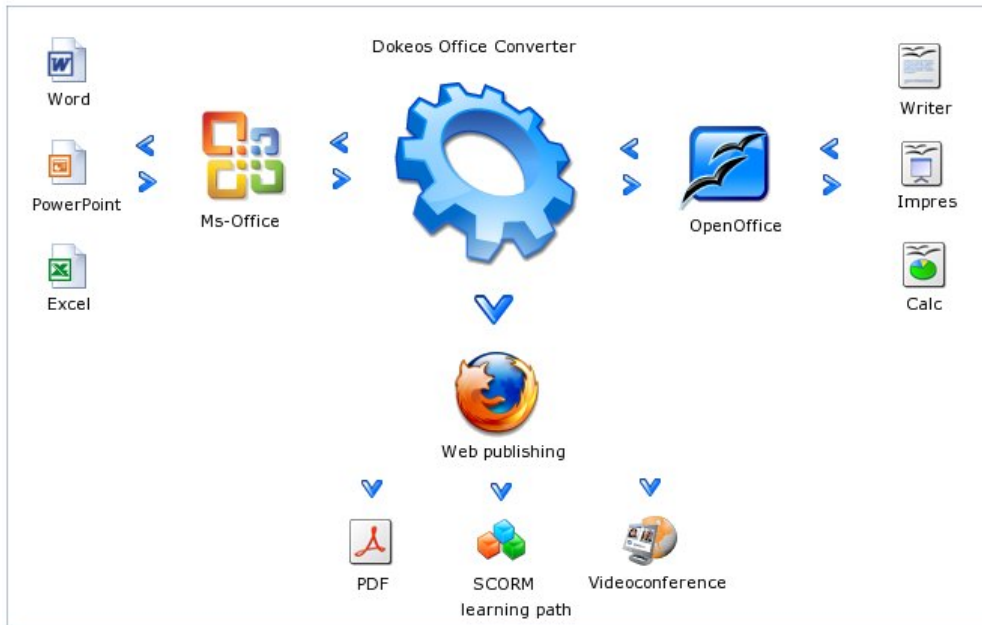

Configuration in Dokeos platform administration, Configure the services, Configure PowerPoint2LearningPath

- host:**localhost**
- Username:
- Ftp password:
- Path to LZX Files:
/lps-latest/dokeos/videoconference/ppt2lpreorder.lzx

NOTE : In case any error should occur, close and restart OpenOffice.org, close and restart the browser. And don't forget that OpenOffice.org has to run (whether in the background on a server or as a graphical interface if your computer is the server) for Oogie to work.



Requirements for Video Conferencing

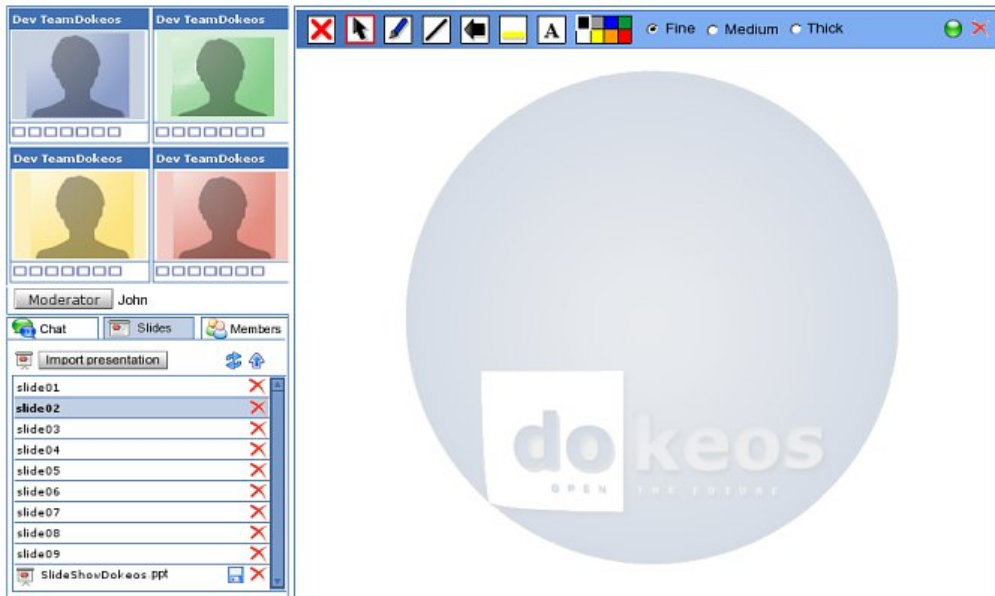

The setup and usage of the Video Conferencing and recording features in Dokeos are provided by customised external packages.

OpenLaszlo ships in a package with its own copy of the Tomcat server.

In order to communicate the user context from Dokeos to OpenLaszlo and Red5, a Tomcat-Apache plugin that handles the communication between Tomcat and Apache is used (*mod_jk*).

- OpenLaszlo: <http://www.openlaszlo.org/>
- Apache Tomcat: <http://tomcat.apache.org/>
- Red5: <http://osflash.org/red5>

Requirements and installation of OpenLaszlo

First, make sure you use the same system user as for the OpenOffice.org server. If you don't have any specific user for that purpose, now is the time to create one.

Depending if the OpenLaszlo server is installed on the same machine as the webserver running Dokeos, different parameters have to be changed

- Download http://www.dokeos.com/download/dokeos-openlaszlo-1_8.tar.gz
- Installation of the OpenLaszlo server: « `sudo tar -xzf dokeos-openlaszlo-1_8.tar.gz` » in the special user's /home directory
- Enter into the new directory: `dokeos-openlaszlo-1.8`
- Check the path to the JAVA_HOME in **Server/tomcat-5.0.24/bin/startup.sh** and **Server/tomcat-5.0.24/bin/startup.sh**



- edit **Server/lps-latest/dokeos/videoconference/host.lzx** in order to define which computer is running Red5 Server.
- Start server with **./Server/tomcat-5.0.24/bin/startup.sh**

Requirements and installation of Red5 Server (version 0.6)

Installation and set-up of the Red5 Server

- Install Red5 from <http://osflash.org/red5>
 - download the debian package
 - `dpkg -i red5_0.6-1_i386.deb`
- Install Dokeos application into your Red5 installation
 - download http://www.dokeos.com/download/dokeos-red5APP-1_8.tar.gz
 - `tar zfvx dokeos-red5APP-1_8.tar.gz`
 - `cp dokeos-red5APP-1.8/* /usr/lib/red5/webapps`
- Configure Red5
 - edit `/usr/lib/red5/conf/red5.properties`

```
rtmp.host_port = 0.0.0.0:1935 # this is the default port of rtmp
rtmp.threadcount = 4
debug_proxy.host_port = 0.0.0.0:1936
proxy_forward.host_port = 127.0.0.1:1935
rtmps.host_port = 127.0.0.1:1945
http.host=0.0.0.0
http.port=5080 #this is the port of the HTTP-Interface
rtmpt.host=0.0.0.0
rtmpt.port=80 #this is the port of the rtmpt (HTTP-Tunnel)
```

- edit `/usr/lib/red5/conf/realm.properties` and change the default administrator password.

More informations over RED5 and Openlaszlo

Please take a look on this page :

http://www.dokeos.com/wiki/index.php/Installing_videoconference



Requirements for the connection of Tomcat with Apache

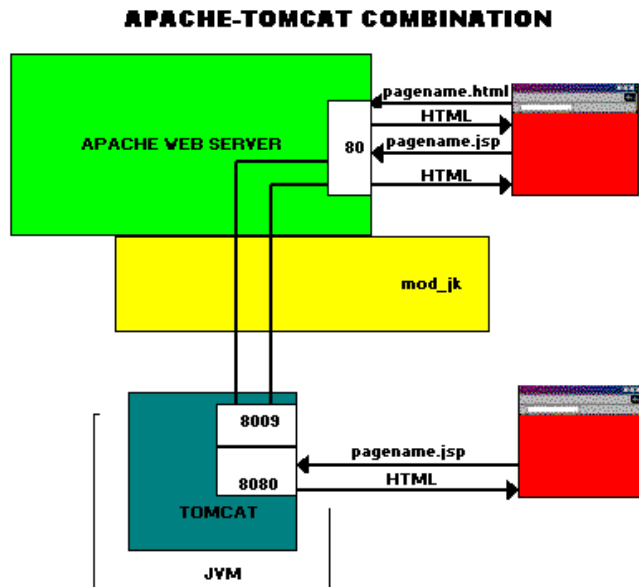

The mod_jk module for Apache2 has to be installed in order to transfer the session data from the Dokeos to the additional plugins. For the installation of the additional modules, see the installation guide of the webserver.

- Apache2 with mod_jk module
 - Install mod_jk (apt-get install libapache2-mod-jk, Ubuntu)
 - enable mod_jk: (a2enmod mod_jk, Ubuntu)
- Configure the workers.properties file
 - edit file /etc/libapache2-mod-jk/workers.properties (Ubuntu)

workers.java_home=/usr/lib/j2sdk1.5-sun (path to the java sdk)
workers.tomcat_home=\$yourInstallation/dokeos-openlaszlo-1.8/Server/tomcat-5.0.24 (path to Tomcat of Openlaszlo)

- Configure the file jk.load
 - edit file /etc/apache2/mods-enabled/jk.load (Ubuntu)

JKLogFile /var/log/apache2/mod_jk.log

JKLogLevel info

JKLogStampFormat "[%a %b %d %H:%M:%S %Y]"

JKMount /lps-latest ajp13

JKMount /lps-latest/dokeos/* ajp13

- Restart/Reload Apache2

Configuration of DokeosVideoServing plugin

The configuration of the VideoServing is done via the admin pages of Dokeos configuration in Dokeos platform admin, Configure the services, Configure VideoConferencingServer

This contains the URL to the videosever (the example is for a local version)

- url: **/lps-latest/videoconferencing/videoconferencing.html** and **/lps-latest/videoconferencing/videoconferencing2.html**



Bandwidth calculation

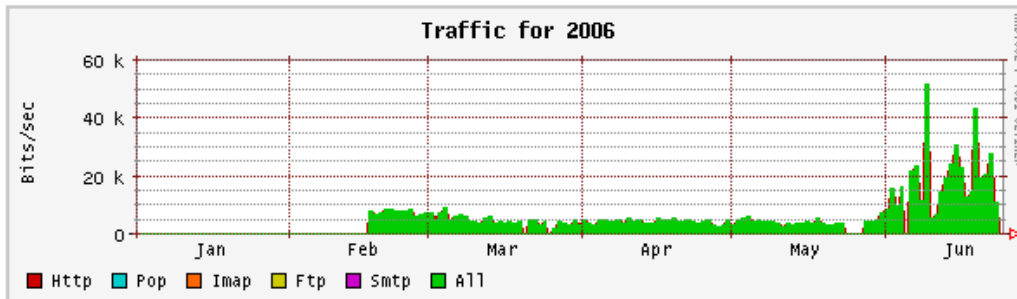

Outgoing Stream: 7KB Incoming Stream: 12KB

1 one2four VideoConference: 4 outgoing streams from every client: $4 \times 7\text{KB} = 28\text{KB}$
incoming traffic on server-side 12 incoming streams to every client:
 $12 \times 12\text{KB} = 144\text{KB}$ outgoing traffic from server-side

1 one2many Conference (up to 50 seats) 1 outgoing streams -> 7KB incoming
traffic 50 incoming streams -> $50 \times 12\text{KB} = 524\text{KB}$ outgoing traffic

More details on installing a new version of Dokeos

Download the Dokeos 1.8 install package (.zip for Windows users or .tar.gz for all others) from the [Dokeos download page](#).

Unzip or untar the downloaded install package. Most current operating systems can do this with a built-in graphical application, if this doesn't work you can open a commandline, go to the download directory and type `tar -zxvf dokeos-community-1.8.tar.gz`

Move by any means (FTP, SCP, local file copy) the contents of the Dokeos install package to your website on your webserver (whether webroot or subdirectory). Your webserver can also be your local computer. Be sure to copy all the folders (archive, home, claroline, courses) as well as all the .php files.

For Windows users who install Dokeos locally: if you use an Apache/PHP/MySQL combination package, just drag and drop the contents of the Dokeos install package into the web directory of the combination package:

- **EasyPHP** - C:\Program Files\easyphp\www\
- **WAMP** - C:\Program Files\wamp\www\
- **XAMP** - C:\Program Files\xamp\www\

2.4. The following directories need to be readable, writeable and executable for the owner of the Apache webservice:

- dokeos/main/inc/conf/
- dokeos/main/garbage/
- dokeos/main/upload/
- dokeos/archive/
- dokeos/courses/
- dokeos/home/

On Linux, Mac OS X and BSD operating systems you can use the CHMOD 777



command for this. In Windows, you may need to check the properties of the folders (by right-clicking on them).

2.5. The following files need to be readable and writeable for everyone:

- dokeos/main/inc/conf/configuration.php (if present)
- dokeos/home/*.html

On Linux, Mac OS X and BSD operating systems you can use the CHMOD 666 command for this. In Windows, you may need to check the properties of the files and folders (by right-clicking on them).

NOTE:

Do not modify the home_*.html files directly. Instead, choose "Configure the homepage" in the Dokeos administration section.

Open a web browser and go to

<http://www.yourserver.org/yoursite/dokeos/index.php> If you install Dokeos locally (not on a server) open: <http://localhost/dokeos/index.php>

Click on the install button and follow instructions. Windows: with combination packages like easyphp, out of the box, login and password for MySQL should probably remain empty.

Configuration and security after installation

- **Protect your configuration file:** make sure no one can overwrite it. You can find the config file in (*dokeos folder*)/main/inc/conf/configuration.php. Make it read-only (windows/xwindows: right-click the file to edit the properties. linux/bsd/macosex: use the chmod 444 command). The config file is created by Apache so you may need to be root user to change its permissions.
- **Protect your installation folder:** if the (*dokeos folder*)/main/install folder is still accessible, someone could install over your existing version (you could lose your data that way). Move the folder somewhere out of the web directories so it is not accessible, change its name, or edit its properties so no one can read or execute it.
- **For better security:** making the files world-writable will help you install, and solves many issues for people without much admin experience. However, it's better security to make the owner of the apache process (often called apache or www-data) also owner of all the dokeos files and folders. This way, these files need only be readable and writable by the Apache process owner, not by the entire world.
- **Configure your Dokeos installation:** in the administration section of Dokeos, you can use the Dokeos Config Settings to adjust the behavior of your installation.
- **Configure Dokeos mail:** most of Dokeos uses the mail settings from the php.ini file. However, the announcements tool uses phpMailer (another free software project) and the settings for this tool can be adjusted in (*dokeos folder*)/main/inc/conf/mail.conf.php.



Upgrading from a previous version of Dokeos

Before upgrading we heavily recommend you do a full backup of the previous Dokeos directories and databases. If you are unsure how to achieve this please ask your hosting provider for advice.

If you upgrade from Dokeos 1.8, you can simply copy the new files over the files of the older version. You should not copy over the home, courses or archive folders, otherwise you might lose data. If you accidentally copy over those folders, you can simply replace them with the folders from your backup.

If you upgrade from a lower version of Dokeos (1.6.x), you'll have to use the built-in upgrade facility, as described below.

Download the Dokeos 1.8 install package (.zip for Windows users or .tar.gz for all others) from the [Dokeos download page](#).

Unzip or untar the downloaded install package. Most current operating systems can do this with a built-in graphical application, if this doesn't work you can open a commandline, go to the download directory and type `tar -zxvf dokeos-community-1.8.tar.gz`

Move the Dokeos directory to a different path from the previous version

WARNING:

Do not delete the previous Dokeos installation directory before installing the new one. When the update is successfully finished, you can remove the old path.

TIP:

If you want Dokeos 1.8 to be installed in the same directory as the previous version :

- move the old directory to a new location (e.g. move dokeos/ to dokeos_old/)
- uncompress Dokeos 1.8 to the old version directory (e.g. uncompress Dokeos 2.0.1 to dokeos/)
- go to next step

The following files need to be readable and writeable by the web server:

- dokeos/main/inc/conf/configuration.php (if present)
- dokeos/home/*.html

On Linux, Mac OS X and BSD operating systems you can use the CHMOD 666 command for this. On Windows, you may need to check the properties of the folders.

NOTE:

The following directories need to be readable, writeable and executable by the web server:

- dokeos/main/inc/conf/
- dokeos/main/garbage/



- dokeos/main/upload/
- dokeos/archive/
- dokeos/courses/
- dokeos/home/

On Linux, Mac OS X and BSD operating systems you can use the CHMOD 777 command for this. On Windows, you may need to check the properties of the folders.

Open a web browser and go to

<http://www.yourserver.org/yoursite/dokeos/index.php>

On Windows, locally, with e.g. easyphp or another combination package, open:

<http://localhost/dokeos/index.php>

Click on the install button, then click on "Upgrade from Dokeos 1.6, 1.6.1, 1.6.2, 1.6.3, 1.6.4, 1.6.5" and follow the instructions.

Troubleshooting

In the future, we will also provide instructions on how to do a "manual" install of Dokeos, by creating the database tables yourself. If you have any problems, go to the [Dokeos website](#) and ask a question on our [support forum](#). Please, read the previous messages first to see if there is already an answer to your question. We also maintain a list of [Frequently Asked Questions](#).

Administration section

To access the Dokeos administration section, open browser, go to your Dokeos address and log in with the admin user. Then you will see a "Platform admin section" link in the header of the web page.

LAB campus - Taibah University Users online: 1

[Campus Homepage](#)
[My courses](#)
[Reporting](#)
[Platform Administration](#)
[Logout](#)

Platform Administration

Users

- ◆ advanced search
- ◆ User list
- ◆ Add users
- ◆ Export the user list into an XML/CSV file
- ◆ Import a list of users from an XML/CSV file

Courses

- ◆ advanced search
- ◆ Course list
- ◆ Create a course
- ◆ Create a course CSV
- ◆ Categories of courses
- ◆ Add classes to a course
- ◆ Add users to a course
- ◆ Add users to a course CSV

LDAP

This part is optional, only organisations with an LDAP server will need to read this. An LDAP module is already provided in Dokeos, but it has to be configured to make it work.

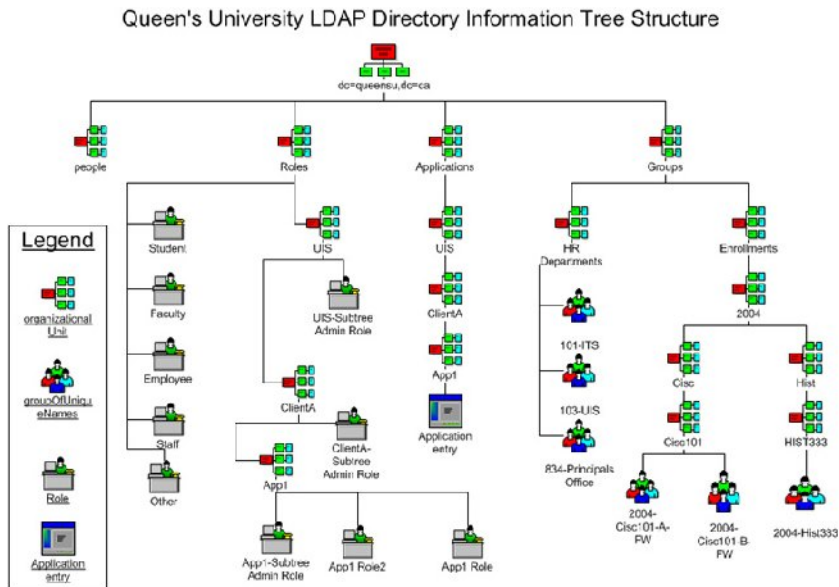

Compiling

Linux servers: It's possible that you have to recompile PHP with LDAP support. Newer distributions also allow downloading rpms for additional packages.



Activating LDAP in Dokeos

In (dokeos folder)/main/inc/conf/configuration.php, around line 90, you see

```
//for new login module  
//uncomment these to activate ldap  
//$extAuthSource['ldap']['login'] = "./main/auth/ldap/login.php";  
//$extAuthSource['ldap']['newUser'] = "./main/auth/ldap/newUser.php";
```

remove the // from the last two lines to activate LDAP.

Settings

Ask the LDAP server admin for the settings:

- ldap server name
- ldap server port (usually 389)
- ldap dc

You must enter these in (dokeos folder)/main/auth/ldap/ldap_var.inc.php

```
//parameters for LDAP module  
$usesLDAP = TRUE;  
$usesCurriculum = FALSE;  
$ldaphost = "myldapservers.com"; // your ldap server  
$ldapport = 389; // your ldap server's port number  
$ldapDc = "dc=xx, dc=yy, dc=zz"; //domain
```

Teacher/student status

If you wish, you can give teacher/student status to dokeos users according to settings in the ldap server. This is not a standard field however, so you'll have to change some code. main/auth/ldap/ldap_var.inc.php around line 189, function putUserInfoInClaroline (\$login, \$infoArray)

```
if (your criterium)  
{  
  $statut = STUDENT;  
}  
else  
{  
  $statut = COURSEMANAGER;  
}
```

If this seems too difficult, the simplest solution is to just put \$statut = STUDENT; and give course manager rights through the administration section.

Protected LDAP servers

Some LDAP servers do not support anonymous use of the directory services In this case, you need code that binds with a name and password - this code has already been provided, just ask on a forum or email for this.



Debian-based GNU/Linux distribution (eg.: Ubuntu) summary of required packages

The following packages have to be installed

- Apache(2)
 - apt-get install apache2
- apt-get install apache2-common
- apt-get install apache2-utils
- apt-get install libapache2-mod-jk
- Mysql
 - apt-get install mysql-server
- apt-get install mysql-common
- php4
 - apt-get install php5
- apt-get install php5-common
- apt-get install php5-mysql
- apt-get install apache2-mod-php5
- Java
 - apt-get install sun-java5-jdk
- Powerpoint and Impress conversion tool
 - apt-get install openoffice.org
- apt-get install xvfb xbase-clients
- Install basic fonts and x-window when a headless server is used
- copy the oooserver.init file to /etc/init.d/
- start the OpenOffice.org server with /etc/init.d/oooserver start
- Install OpenLaszlo and Tomcat
 - download dokeosopenlaszlo_1_8.tar.gz
- tar -xvzf dokeosopenlaszlo_1_8.tar.gz
- change if needed the references to java_home
- start the server with \$installdir/lps-latest/Server/tomcat-5.0.24/bin/startup.sh
- Install Red5 server
 - download dokeosred5_1_8.tar.gz
- tar -xvzf dokeosred5_1_8.tar.gz
- change if needed the references to java_home
- start the server with \$installdir/dist/red5.sh
- Install Dokeos
 - download dokeos.tar.gz
- tar -xvzf dokeos.tar.gz
- change the Apache setting
- restart your web-server
- goto your Dokeos homepage